

Powered by



# TPL 121500A ▶ 12V 150Ah

TPL 121500A is a front terminal battery up to 12 years expected life under normal float charge As with all CSB batteries, all are rechargeable, highly efficient, leak proof and maintenance free.



MH14533(N)



No.:041005117



CSB-manufactured VRLA batteries are UL-recognized components under UL924 and UL1989.

CSB is also certified by ISO 9001 and ISO 14001.

## Specification

Cells Per Unit	6
Voltage Per Unit	12
Capacity	150Ah @ 8hr-rate to 1.75V per cell @25 °C(77°F)
Weight	Approx. 53.6kg(118.17 lbs)
Maximum Discharge Current	800A(5sec)
Internal Resistance	Approx. 6.5 m Ω
Operating Temperature Range	Discharge: -15°C~50°C ( 5°F~122°F) Charge: -15°C~40°C ( 5°F~104°F) Storage: -15°C~40°C ( 5°F~104°F)
Nominal Operating Temperature Range	25°C±3°C(77°F±5°F)
Float Charging Voltage	2.275 ± 0.025V / Cell at 25 °C (77°F) Temp. Coefficient ±3.3mV/°C(±1.8mV/°F)
Recommended Maximum Charging Current Limit	45A
Equalization / Cycle Use Charging Voltage	2.45V Temps coefficient ±0.05mV/°C(±1.8mV/°F)
Terminal	I2-Thread lead alloy recessed terminal to accept M6 bolt
Terminal Hardware Initial Torque	120-in-lbs.(13.58 N-m)
Container Material	ABS(UL94-V0) & (UL94-HB) / L.O.I higher than 28

## Dimensions :

Unit: mm (inch)

Overall Height (H)	Length (L)	Width (W)
323.0±2.5 (12.72±0.10)	547.0±2.5(21.54±0.10)	125.6±1.5 (4.94±0.06)

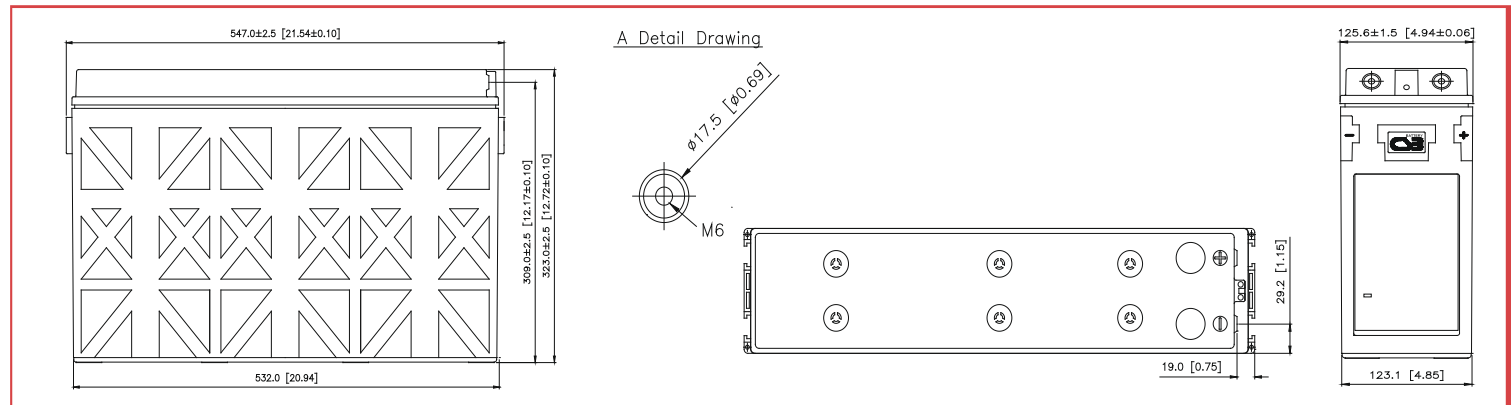

## Constant Current Discharge Characteristics Unit:A (25°C ,77°F)

F.V/Time	15MIN	30MIN	60MIN	90MIN	2HR	3HR	4HR	5HR	6HR	7HR	8HR	10HR	20HR
1.67V	278	177	104	76.4	60.2	44.3	35.7	29.6	25.3	22.0	19.5	15.9	8.34
1.70V	263	170	100	74.3	59.5	43.9	35.3	29.3	24.9	21.8	19.1	15.8	8.25
1.75V	238	158	95.5	72.1	57.9	42.7	34.2	28.1	24.0	21.0	18.8	15.4	8.06
1.80V	211	146	90.2	68.1	55.6	41.3	32.6	27.2	23.4	20.3	18.1	15.0	7.88
1.83V	195	138	85.0	65.2	53.3	39.8	31.7	26.4	22.8	19.8	17.5	14.4	7.69
1.85V	184	133	82.9	63.7	52.1	38.9	31.0	25.8	22.2	19.4	17.3	14.3	7.50
1.90V	158	118	77.2	62.6	48.1	35.4	28.1	23.4	20.0	17.6	15.8	13.0	6.94

## Constant Power Discharge Characteristics Unit:W (25°C ,77°F)

F.V/Time	15MIN	30MIN	60MIN	90MIN	2HR	3HR	4HR	5HR	6HR	7HR	8HR	10HR	20HR
1.67V	2,954	1,909	1,135	843	669	497	402	334	286	249	221	180	94.7
1.70V	2,821	1,855	1,122	833	667	496	400	333	284	248	218	179	94.4
1.75V	2,575	1,747	1,084	824	666	489	394	324	277	243	217	178	93.4
1.80V	2,322	1,627	1,033	785	646	480	380	318	274	238	212	175	92.5
1.83V	2,164	1,545	1,002	768	628	467	372	311	268	233	207	170	90.9
1.85V	2,057	1,495	977	753	618	459	367	305	263	230	204	169	89.2
1.90V	1,812	1,370	909	693	572	423	337	281	240	212	189	157	83.5

Ratings presented herein are subject to revision without notice. Please refer to [www.csb-battery.com](http://www.csb-battery.com) to confirm the latest version.

### Trickle (or Float) Service Life

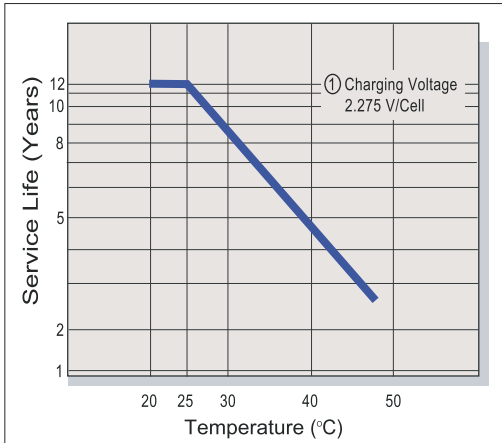

### Capacity Retention Characteristic

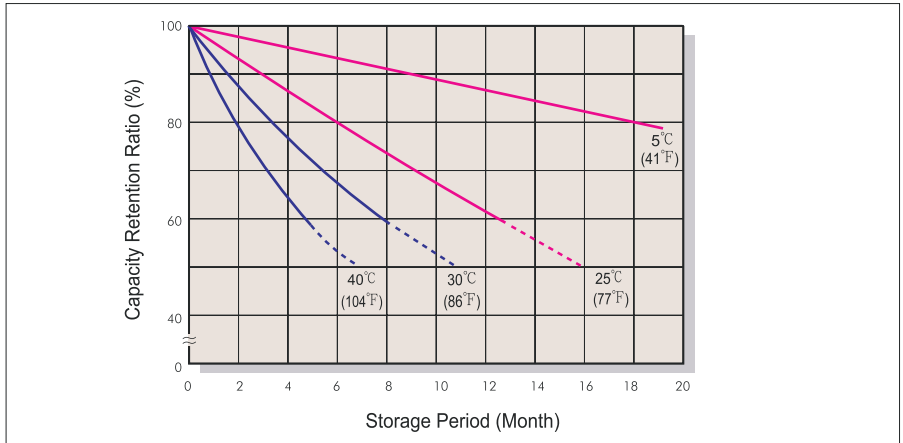

### Battery Voltage and Charge Time for Standby Use

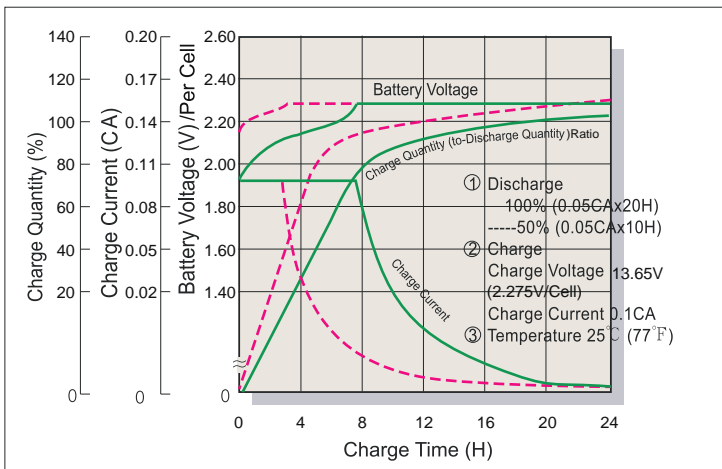

### Cycle Service Life

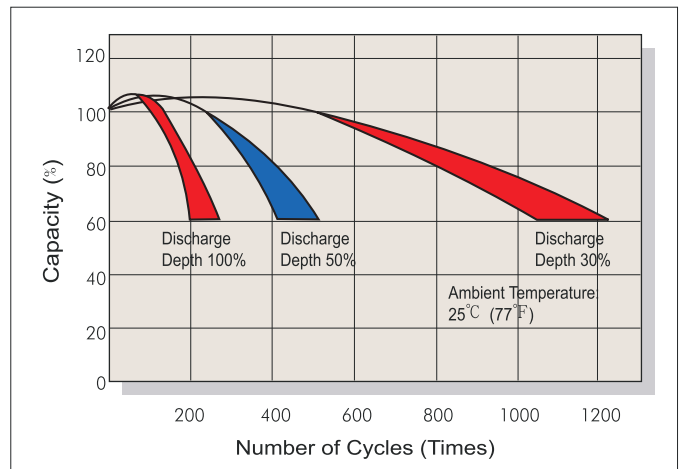

### Battery Voltage and Charge Time for Cycle Use

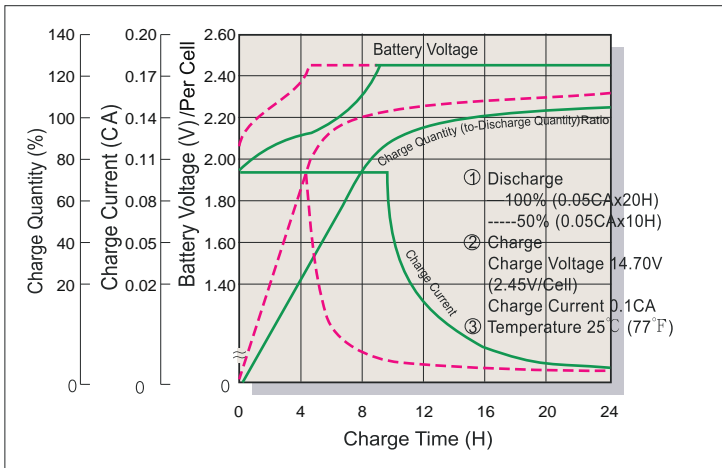

### Terminal Voltage (V) and Discharge Time

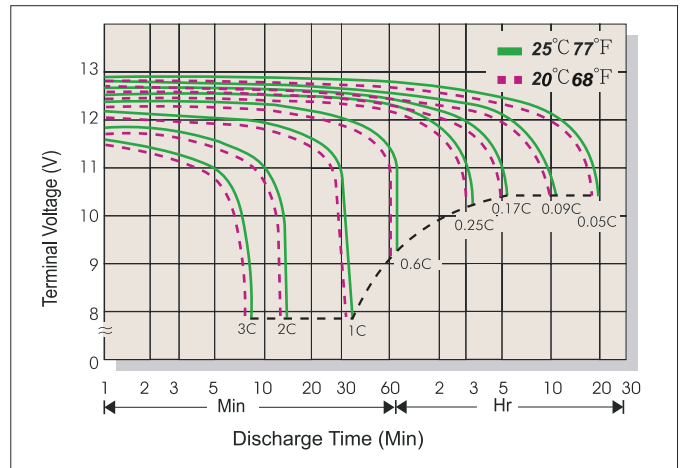

### Charging Procedures

Application	Charge Voltage(V/Cell)			Max.Charge Current
	Temperature	Set Point	Allowable Range	
Cycle Use	25°C(77°F)	2.45	2.40~2.50	0.3C
Standby	25°C(77°F)	2.275	2.25~2.30	

### Discharge Current VS. Discharge Voltage

Final Discharge Voltage V/Cell	1.75	1.70	1.60	1.30
Discharge Current(A)	0.2C>(A)	0.2C<(A)<0.5C	0.5C<(A)<1.0C	(A)>1.0C

Sales Office URL:WWW.CSB-BATTERY.COM

**GLOBAL HQ**  
**CSB BATTERY CO., LTD. (TAIWAN)**  
 Tel : +886-2-2880-5600  
 Fax : +886-2-2888-3300  
 mail : service@csb-battery.com.tw

**BEIJING OFFICE. (CHINA)**  
**CSB BATTERY TECHNOLOGIES (BEIJING) CO., LTD.**  
 Tel : +86-10-5820-5336/5338  
 Fax : +86-10-58203053  
 mail : chinasl@csb-battery.com

**AMERICA HQ**  
**CSB BATTERY TECHNOLOGIES INC. (U.S.A)**  
 Tel : +1-817-244-7777/1-(800)3-CSB-USA(272872)  
 Fax : +1-817-244-4445  
 mail : csb@csb-battery.com

**SHANGHAI OFFICE. (CHINA)**  
**CSB BATTERY LOGISTIC (SHANGHAI) CO., LTD.**  
 Tel : +86-21-5046-1622/5046-0833  
 Fax : +86-21-5064-1046  
 mail : chinasl@csb-battery.com

**EUROPE HQ**  
**CSB Battery Europe BV.**  
 Tel : +31(0)-180-418-140  
 Fax : +31(0)-180-418-327  
 mail : eurosales@csb-battery.eu

**SHENZHEN OFFICE.( CHINA )**  
**CSB BATTERY LOGISTIC ( SHANGHAI ) CO., LTD.**  
 Tel : +86-755-8831-6488/6396/6356  
 Fax : +86-755-8831-6548  
 mail : she@csb-battery.com.cn